

FAGERHULT SE - 566 80 Habo

Multilume Hydro LED

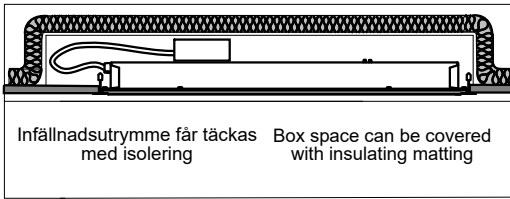
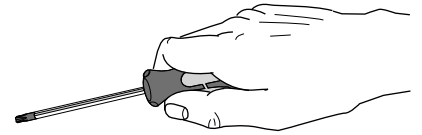

[mm]

	A	B	C
300x600	400	700	80
300x1200	400	1300	80
600x600	700	700	80

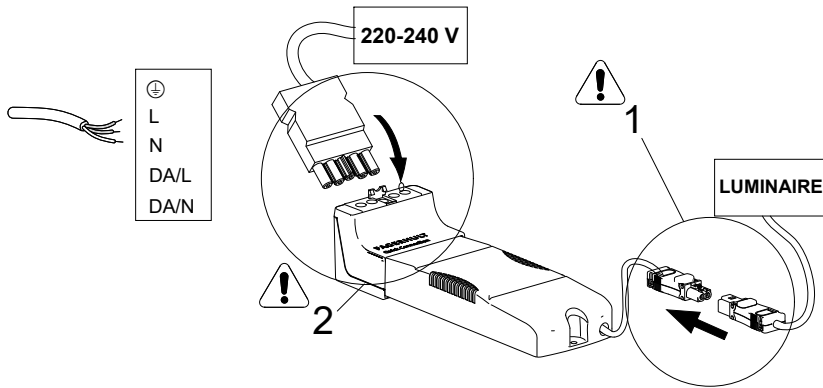

[mm]

	A	B
300x600	277	577
300x1200	277	1177
600x600	577	577

DA-	S	Grundläggande isolering mellan nät och styrledning.
DA+		
N	GB	Basic insulation between mains and control wiring.
L		



No2.
T20 Max 2,5Nm
T20 Max 1,0Nm

No4.
T20 Max 2,5Nm
T20 Max 1,0Nm

No3.
T20 Max 2,5Nm
T20 Max 1,0Nm

No1.
T20 Max 2,5Nm
T20 Max 1,0Nm

MAX
12 kg

Max 40mm

When installing luminaire:
Press luminaire against ceiling or T-bars
and cross-tighten screws with right torque.

T20 Max 2,5Nm x4
T20 Max 1,0Nm

- GB For use in ventilated or unventilated spaces
- S För användning i ventilerade eller oventilerade utrymme

- S Ljuskälla, drivdon och anslutningskabel ska enbart bytas ut av tillverkaren eller dess utsedda person.
- GB The light source, control gear and external cable shall exclusively be replaced by the manufacturer or its designated person.

- S Det är lämpligt att denna information överlämnas till användaren av anläggningen.
- GB It is appropriate that this information is passed on to the users of the installation.

- Observera gällande hanteringsföreskrifter mot elektrostatisk urladdning.
- Notice management regulations against electrostatic discharge.

Manufactured by Fagerhult Sweden.
For UK market importer Fagerhult UK
33-34 Dolben Street, London, SE1 OUQ

FAGERHULT

SE - 566 80 Habo

ML Hydro LED surface mounted

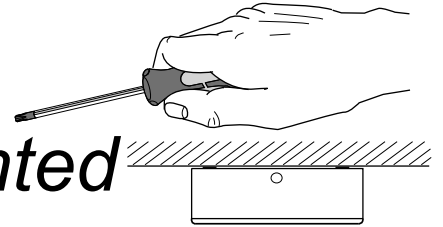

Observera gällande hanteringsföreskrifter mot elektrostatisk urladdning.
Notice management regulations against electrostatic discharge.

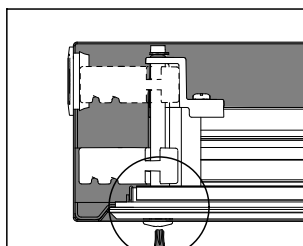
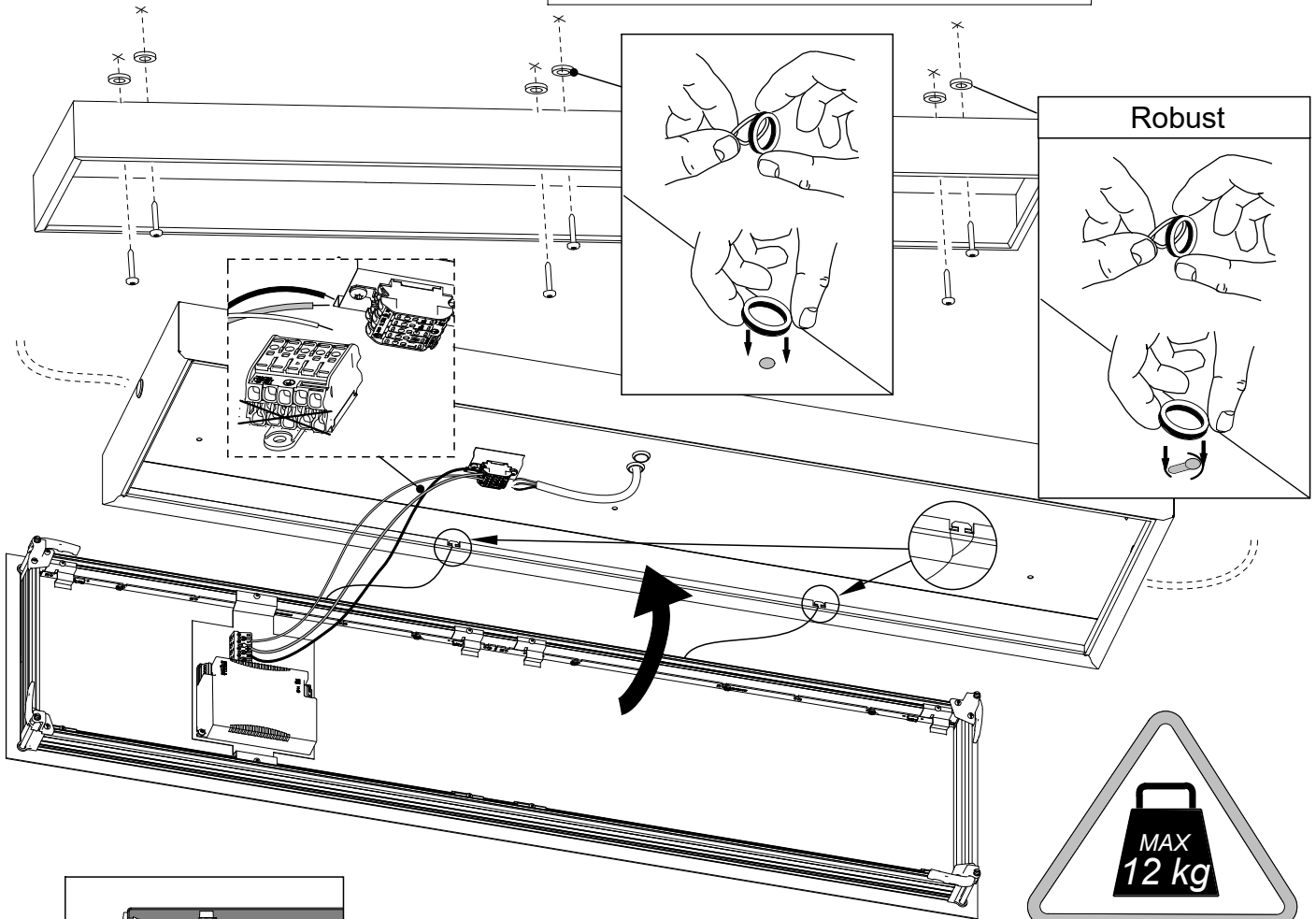
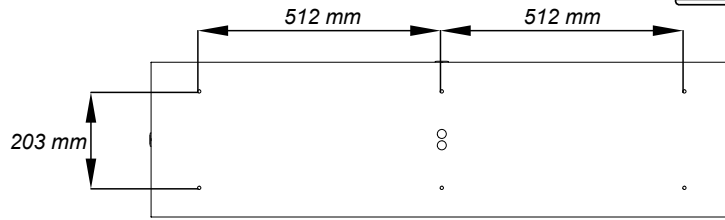

When installing luminaire:
Press frame against body and cross-tighten screws with right torque.

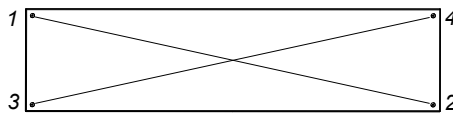

- T20 Max 2,5 Nm
- T20 Max 1,0 Nm

- (S)** Ljuskälla och drivdon ska enbart bytas ut av tillverkaren eller dess utsedda person.
- (GB)** The light source and control gear shall only be replaced by the manufacturer or its designated person.

- (S)** Grundläggande isolering mellan nät och styr ledning.
- (GB)** Basic insulation between mains and control wiring.

- (S)** Det är lämpligt att denna information överlämnas till användaren av anläggningen.
- (GB)** It is appropriate that this information is passed on to the users of the installation.

Manufactured by Fagerhult Sweden.
For UK market importer Fagerhult UK
33-34 Dolben Street, London, SE1 0UQ

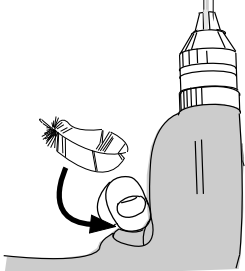

Anti-Ligature

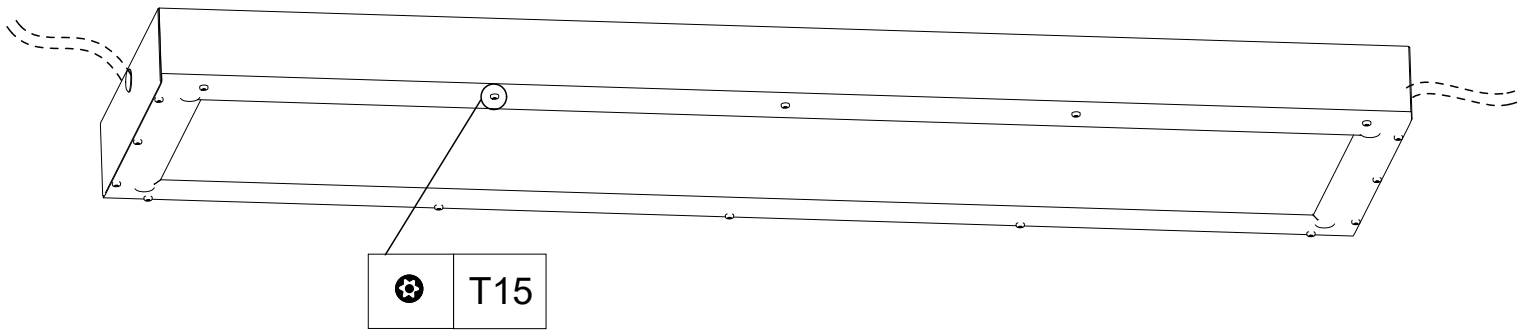
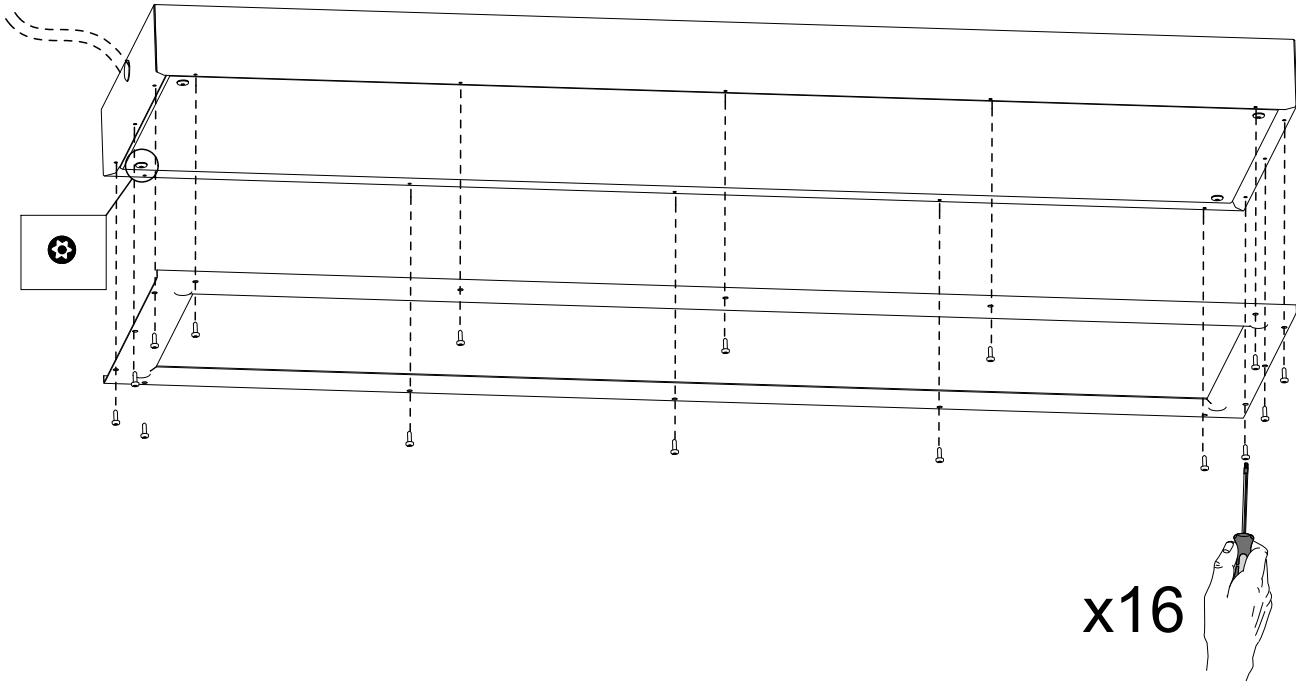

FAGERHULT SE - 566 80 Habo

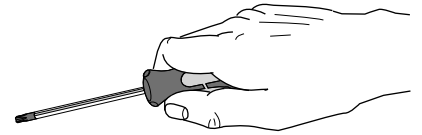

Multilume Hydro LED Anti-ligature

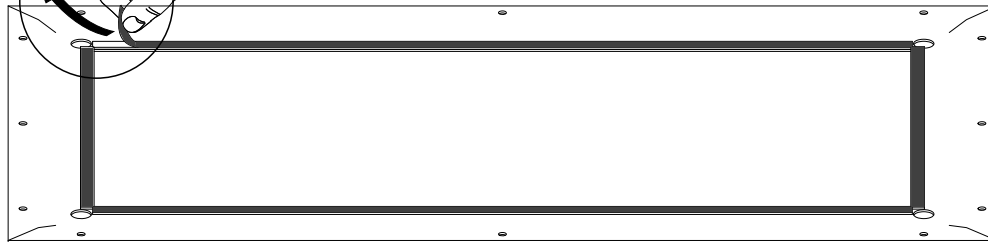
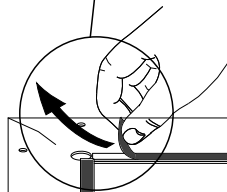
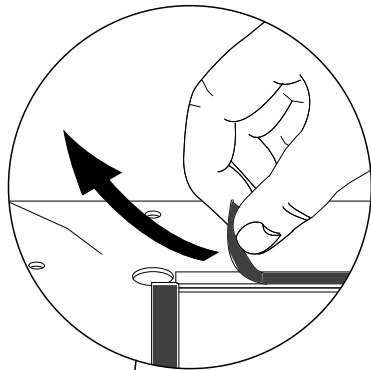

[mm]

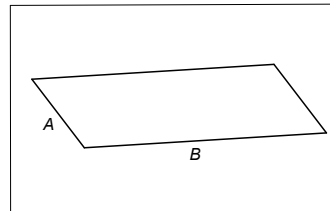

	A	B	Screws for ceiling needed (not incl.)
300x600	355	655	12
300x1200	355	1255	12
600x600	655	655	16



5408022 Utgåva/Edition 02

S Det är lämpligt att denna information överlämnas till användaren av anläggningen.

GB It is appropriate that this information is passed on to the users of the installation.

Manufactured by Fagerhult Sweden.
For UK market importer Fagerhult UK
33-34 Dolben Street, London, SE1 0UQ

FAGERHULT

SE - 566 80 Habo

ML Hydro LED TW & Amber

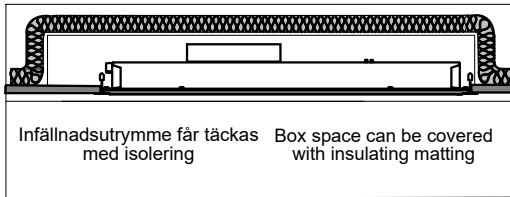
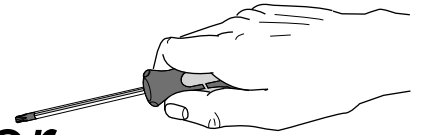

[mm]

	A	B	C
300x600	400	700	72
300x1200	400	1300	72
600x600	700	700	72

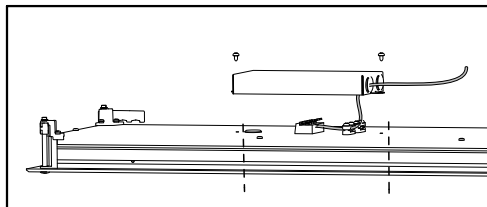

[mm]

	A	B
300x600	277	577
300x1200	277	1177
600x600	577	577



No2.
 T20 Max 2,5Nm
 T20 Max 1,0Nm

No4.
 T20 Max 2,5Nm
 T20 Max 1,0Nm

No3.
 T20 Max 2,5Nm
 T20 Max 1,0Nm

No1.
 T20 Max 2,5Nm
 T20 Max 1,0Nm



Max 40mm

When installing luminaire:
 Press luminaire against ceiling or T-bars
 and cross-tighten screws with right torque.

Robust Others

T20 Max 2,5Nm
 T20 Max 1,0Nm

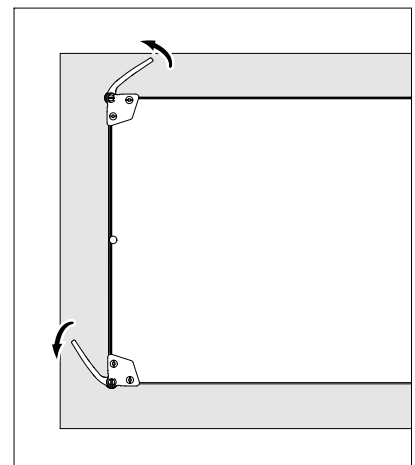
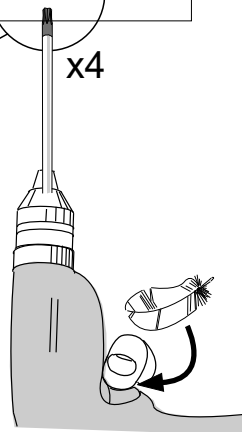
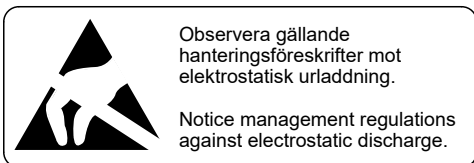
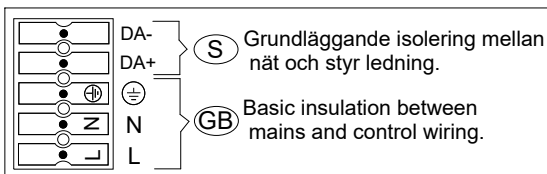

(S) Ljuskälla och drivdon ska enbart bytas ut av tillverkaren eller dess utsedda person.
 (GB) The light source and control gear shall only be replaced by the manufacturer or its designated person.

(GB) For use in ventilated or unventilated spaces
 (S) För användning i ventilerade eller oventilerade utrymme

(S) Det är lämpligt att denna information överlämnas till användaren av anläggningen.

(GB) It is appropriate that this information is passed on to the users of the installation.

Manufactured by Fagerhult Sweden.
 For UK market importer Fagerhult UK
 33-34 Dolben Street, London, SE1 OUG