

# FAGERHULT

SE - 566 80 Habo

## Discovery

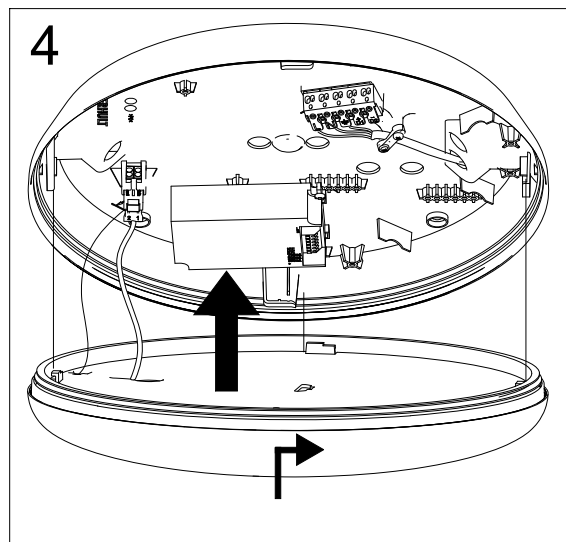
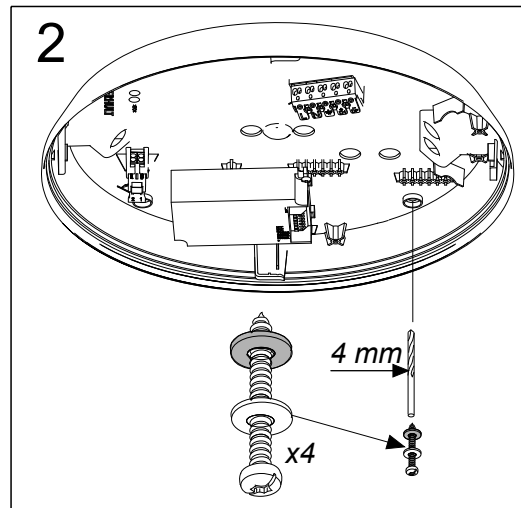
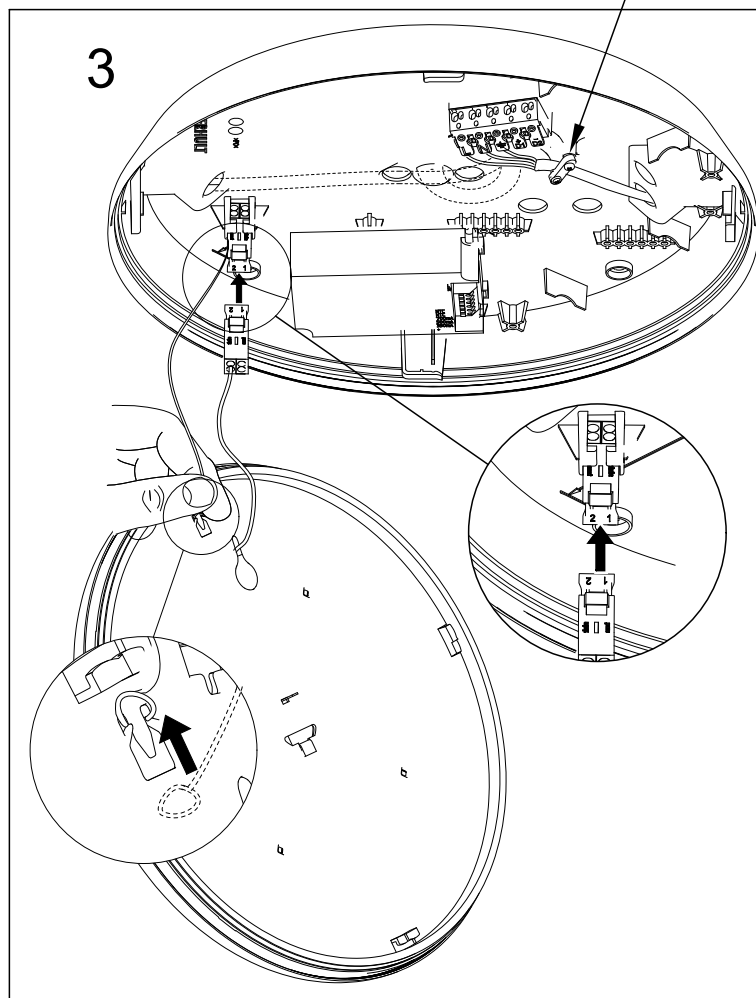
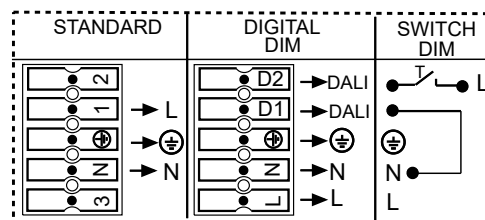
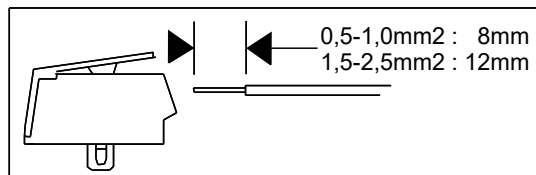
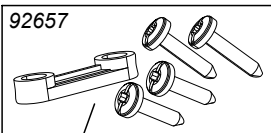
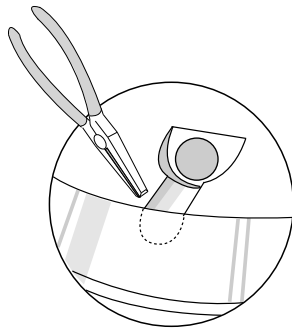
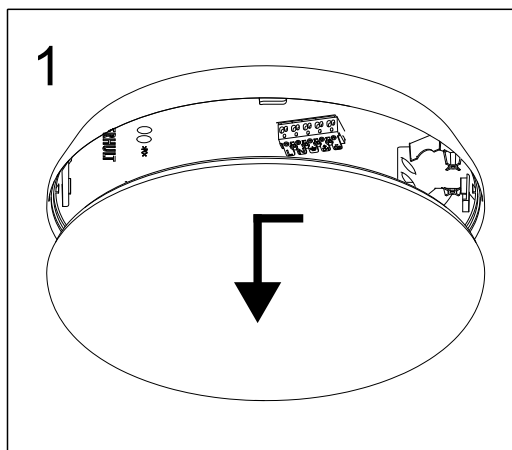
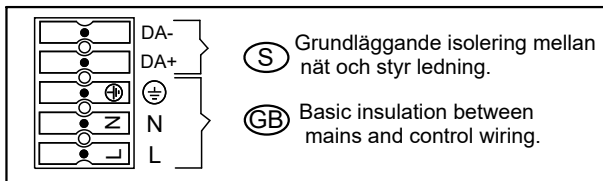
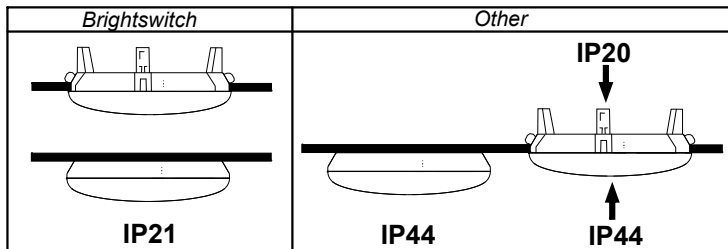
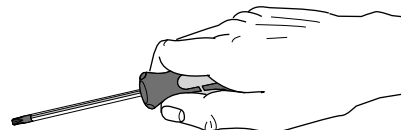

5007560 Utgåva/Edition 10

**(S)** Ljuskälla och drivdon ska enbart bytas ut av tillverkaren eller dess utsedda person.

**(GB)** The light source and control gear shall only be replaced by the manufacturer or its designated person.

**(S)** Det är lämpligt att denna information överlämnas till användaren av anläggningen.

**(GB)** It is appropriate that this information is passed on to the users of the installation.

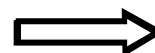

# Emergency

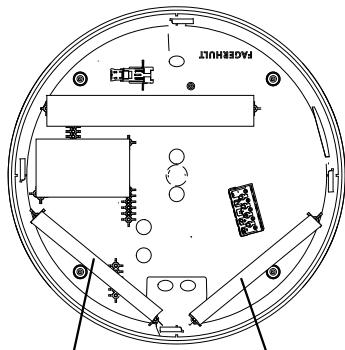
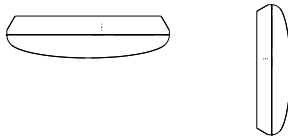

**BATTERY NIMH 4,8V 4Ah**

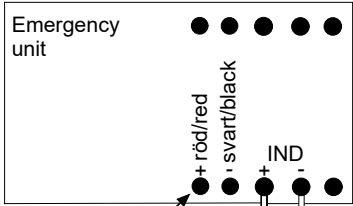

Red cable from batteri  
remove from clamp and  
connect to emergency unit

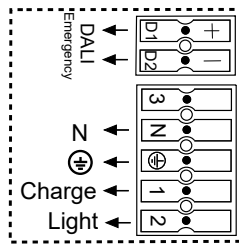
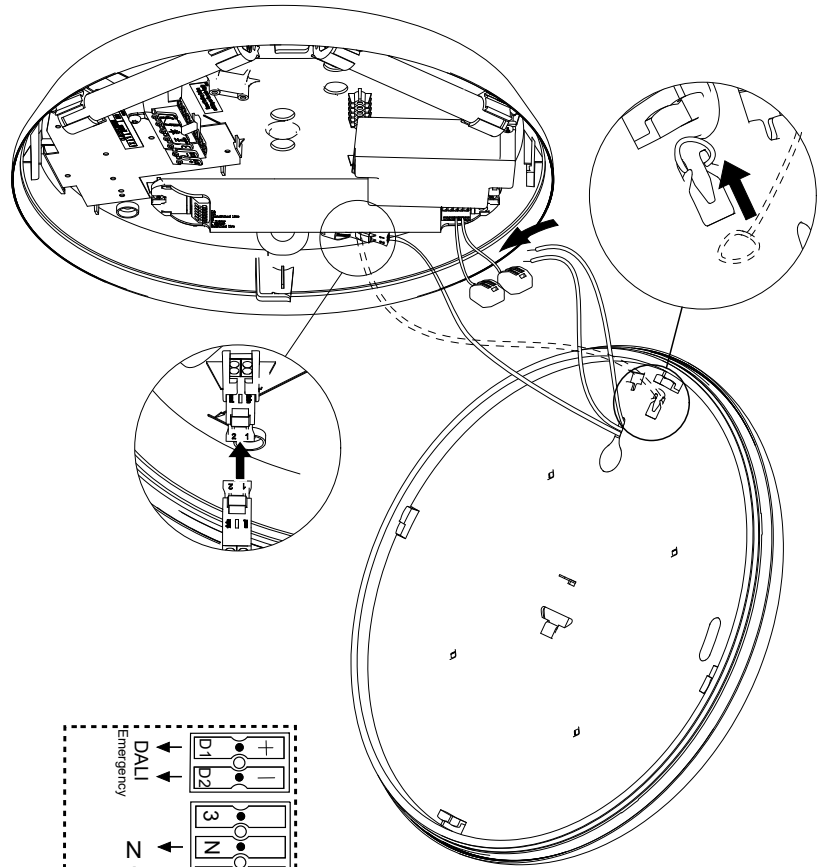
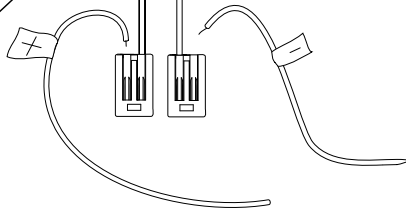

# E-sense Brightswitch ON/OFF

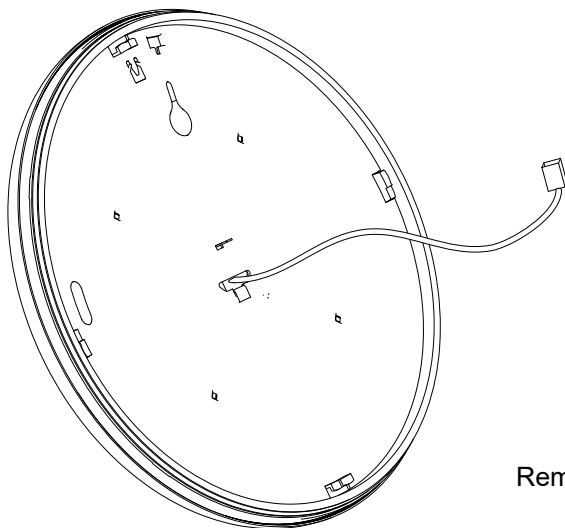
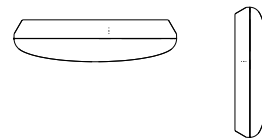

Remote controll e-Sense brigthswitch 86359

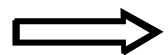

5007580 Utgåva/Edition 10

**S** Det är lämpligt att denna information överlämnas till användaren av anläggningen.

**GB** It is appropriate that this information is passed on to the users of the installation.

Manufactured by Fagerhult Sweden.  
For UK market importer Fagerhult UK  
33-34 Dolben Street, London, SE1 0UQ